

DORENBERG

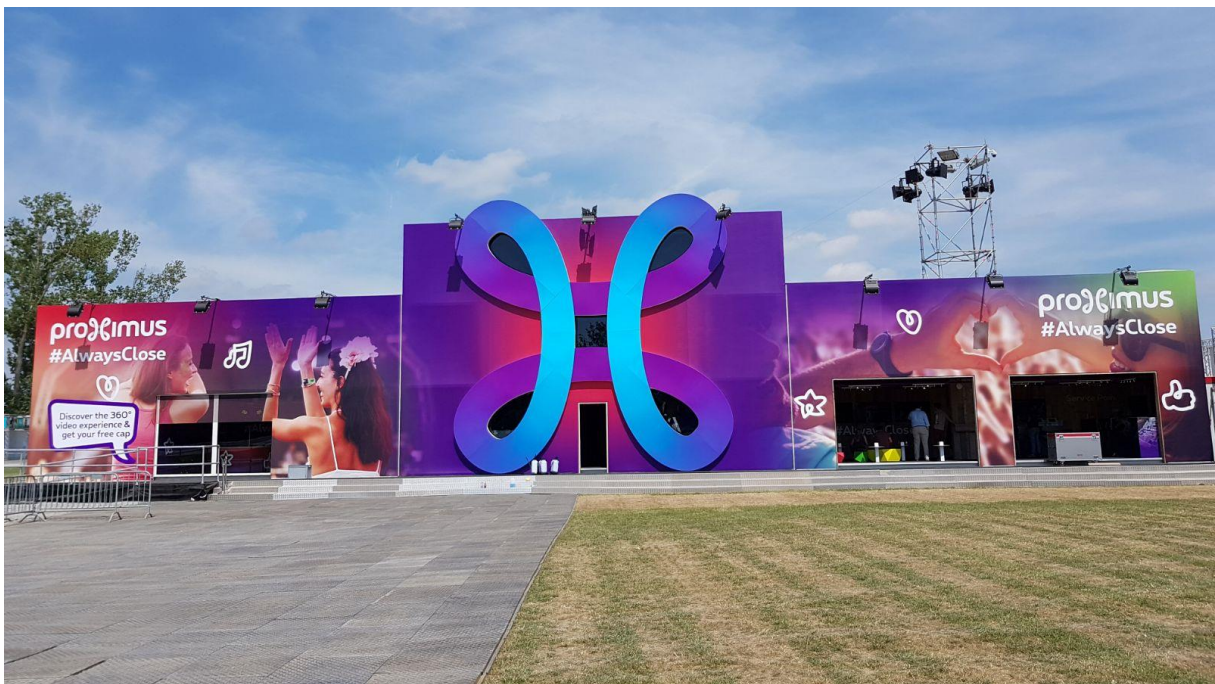

KLOPPROFIELEN

Profielen met geul en een pvc strip waarmee een pvc banner (frontlit, backlit, mesh) kan opgespannen worden. Wij verdelen de profielen van het Franse ISERMATIC, ook gekend onder de productnaam CRYSTAL. Hiermee slaan we twee vliegen in één klap: CRYSTAL combineert de **hoogste kwaliteit** met het **breedste gamma**. Alle profielen en accessoires op voorraad. Eveneens zaagservice.



Proximusstand Werchter met klopprofielen P100

ISERMATIC™
Systèmes

CRYSTAL™
Système breveté de tension de toiles 

REALISATIES



kubus met klopprofielen P100



Meer realisaties vindt u achteraan dit document

HET GAMMA

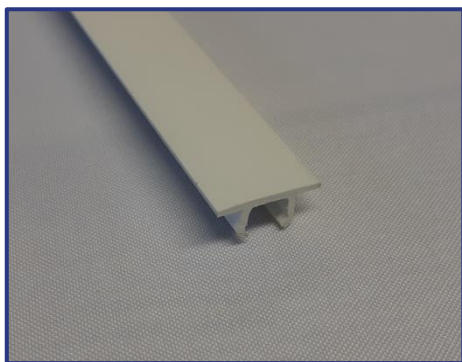

JONC JN

PVC-strip in wit binnengebruik
lengte 3m50

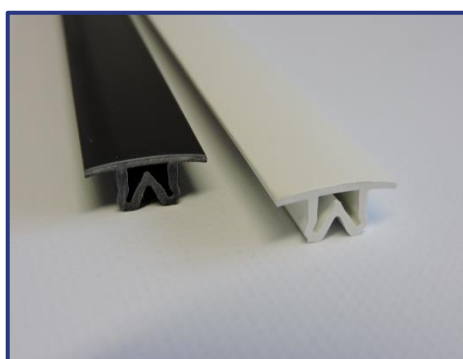

JONC JR

PVC-strip in wit buitengebruik
zwart buitengebruik onder voorbehoud

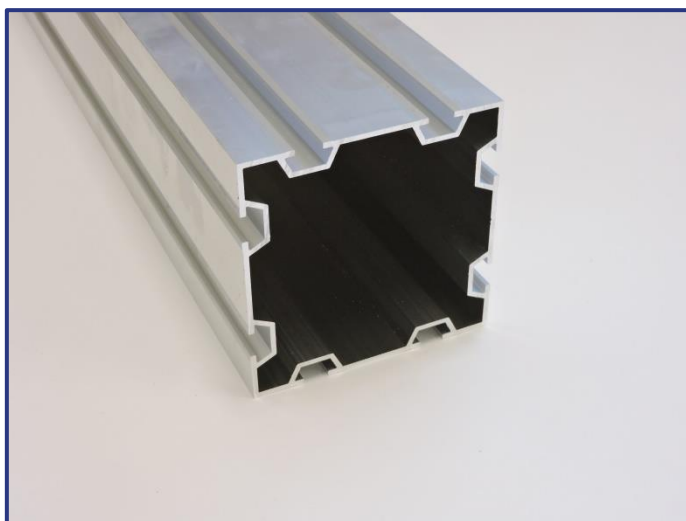

P100

Productomschrijving:

10x10cm

8 geulen

3kg/lm

Toepassingen:

volumes

geveltoepassing

zelfdragende constructies

Uitvoering: alu brut

Lengte: 4m en 5m

Accessoires: EQS100

EQARTS100

EQASS S100

MANCH S100

PIED S100

POTEN S100

VIS S100

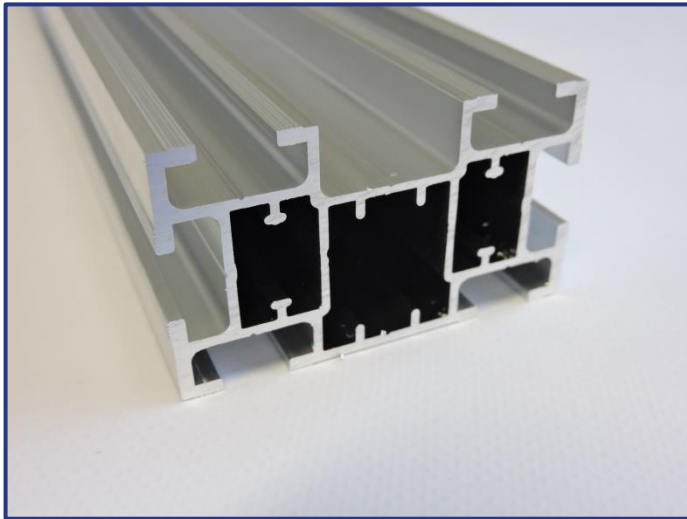

KT+

Productomschrijving:

64x36,5mm

6 geulen

1,4kg/lm

Toepassingen:

geveltoepassing

zelfdragende constructies

Uitvoering: alu brut of wit gelakt

Lengte: 3m50 en 5m

Accessoires: CLM EQABS
EQKT+MUR TU 10CM
EQART KT+ EQKT
L40

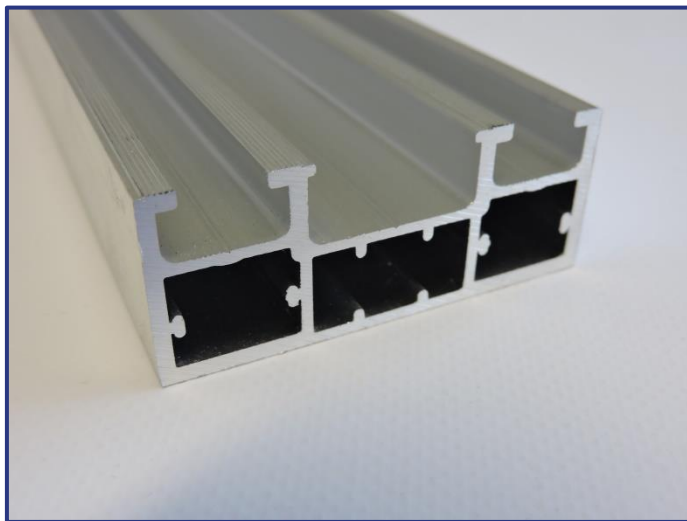

KT

Productomschrijving:

60x24mm

2 geulen

1kg/lm

Toepassingen:

geveltoepassing

Uitvoering: alu brut

Lengte: 3m50 en 5m

Accessoires: EQABS 2
TU 12
L30

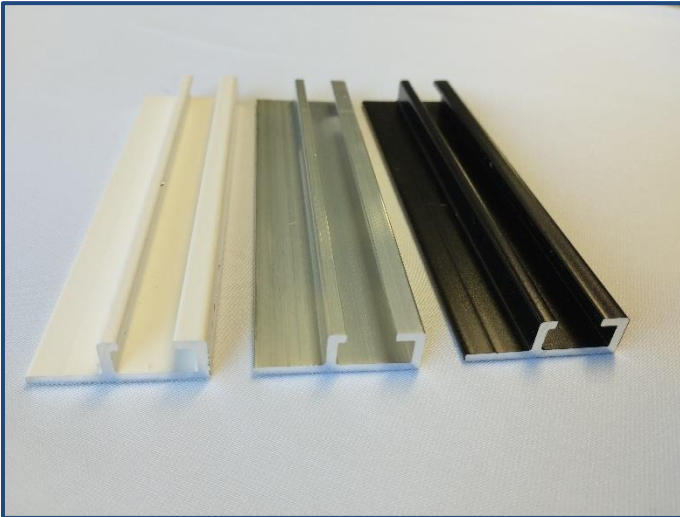

KTF

Productomschrijving:

34x10mm

0,302kg/lm

Toepassingen:

Voor kaders waarvan de korte zijde niet langer is dan 2m50

Ondergrond: op volledig vlakke muur of op onderstructuur met metalen kokers of houtwerk

Uitvoering: alu brut, wit gelakt, zwart gelakt

Lengte: 3m50 en 5 m

Accessoires: geen

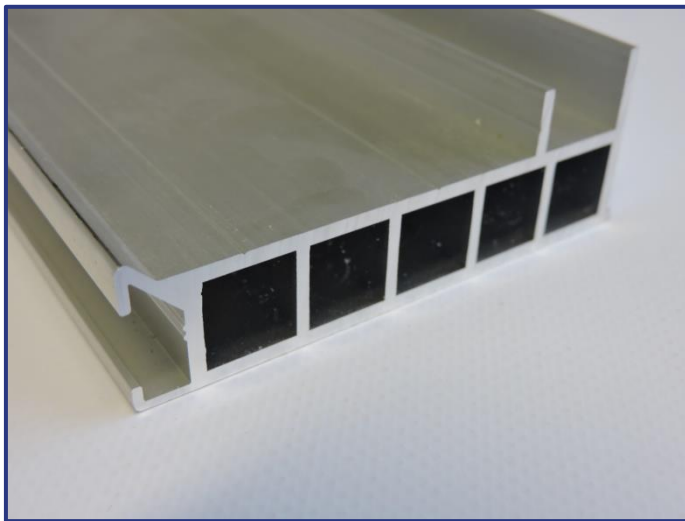

KPPS SLIM

Productomschrijving:

80x29mm

1 geul

1,34kg/lm

Toepassingen:

lichtbakken

spanlat aan voorzijde kader

Uitvoering: alu brut of wit gelakt

Lengte: 3m50 en 7m

Accessoires: EQABS 2

SX 30

FIX 30

SX 50

FIX 50

EQERA 2

EQ120

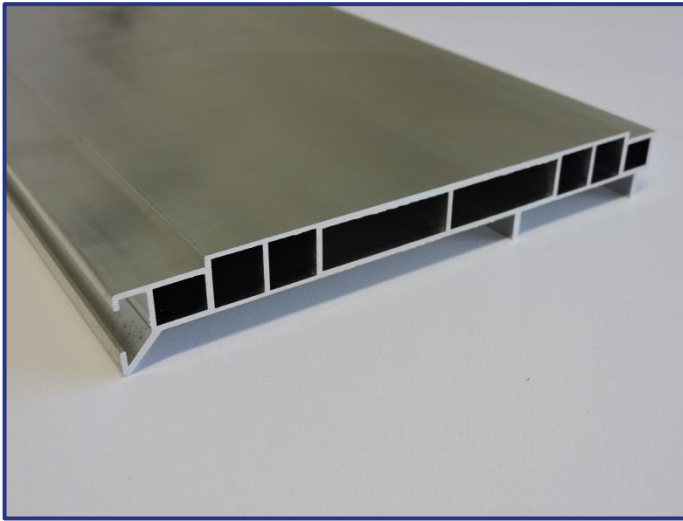

KPPS

Productomschrijving:

160x22mm

1 geul

1,6kg/lm

Toepassingen:

lichtbakken

spanlat aan voorzijde kader

Uitvoering: alu brut of wit gelakt

Lengte: 3m50 en 7m

Accessoires:

EQABS	FIX 50
EQERA	SX 30
EQ120	CAV
FIX 30	EQ
L20	SX 50
EQRAID	

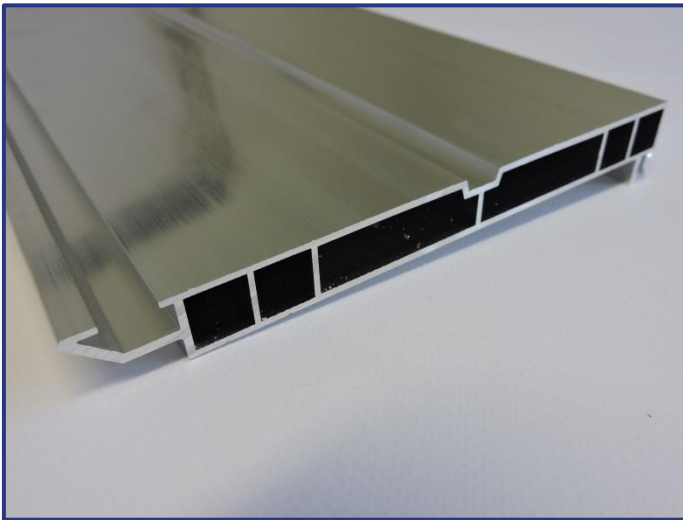

KPPS SF

Productomschrijving:

160x22mm

1 geul

1,6kg/lm

Toepassingen:

lichtbakken

spanlat aan zijkant kader

Uitvoering: alu brut of wit gelakt

Lengte: 3m50 en 7m

Accessoires:

EQABS	FIX 50
EQERA	CAV
SX 30	EQ120
FIX 30	EQ
L20	SX 50
EQRAID	

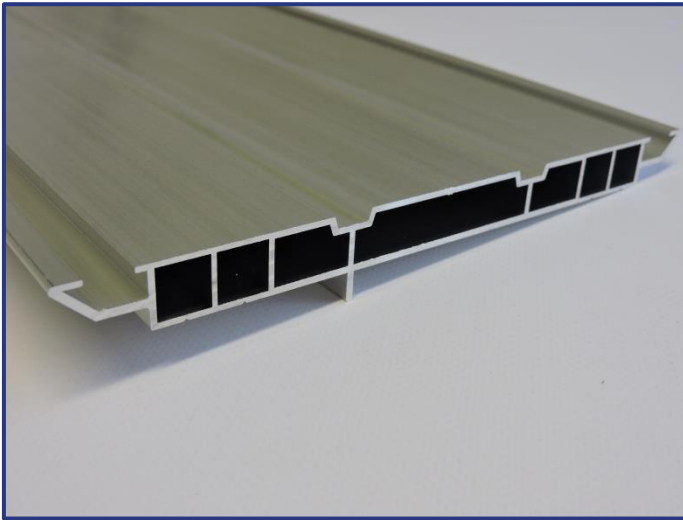

KPPS DF

Productomschrijving:

190x22mm

2 geulen

1,8kg/lm

Toepassingen:

dubbelzijdige lichtbakken
spanlat aan zijkant kader

Uitvoering: alu brut of wit gelakt

Lengte: 3m50 en 7m

Accessoires:

EQABS	FIX 50
EQERA	L20
SX 30	EQ120
CAV	FIX 30
EQ	SIX 50
EQRAID	

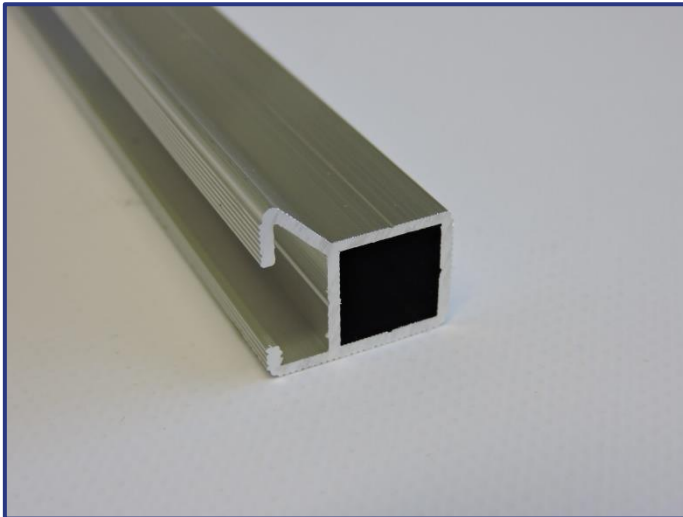

KTN

Productomschrijving:

20x22mm

1 geul

0,228kg/lm

Toepassingen:

binnengebruik

buitengebruik beperkt

vlakke muur

Uitvoering: alu brut

Lengte: 3m50

Accessoires: EQABS
TU 10CM

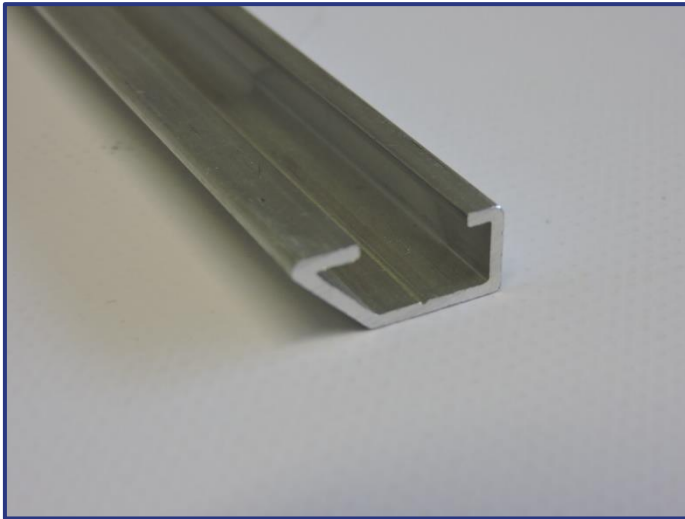

C

Productomschrijving:

20x8mm

1 geul

0,117kg/lm

Toepassingen:

binnengebruik

ook in combinatie met profiel KTN

Uitvoering: alu brut

Lengte: 3m50

Accessoires: geen

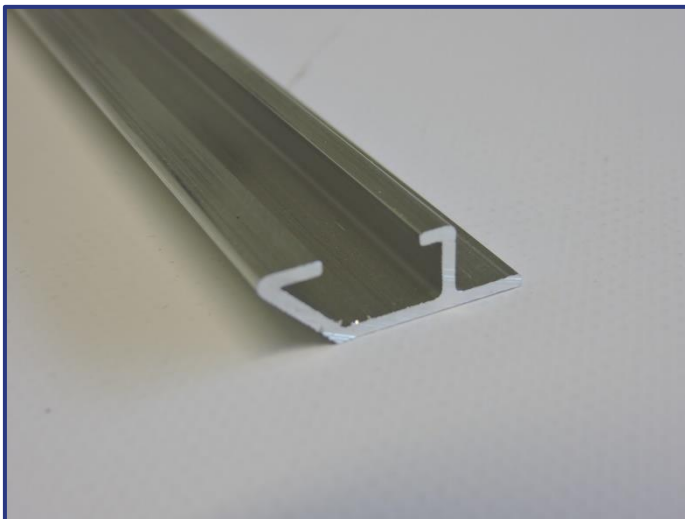

KTA

Productomschrijving:

27x9mm

1 geul

0,168kg/lm

Toepassingen:

binnengebruik

buitengebruik beperkt

vlakke muur

Uitvoering: alu brut

Lengte: 3m50

Accessoires: geen

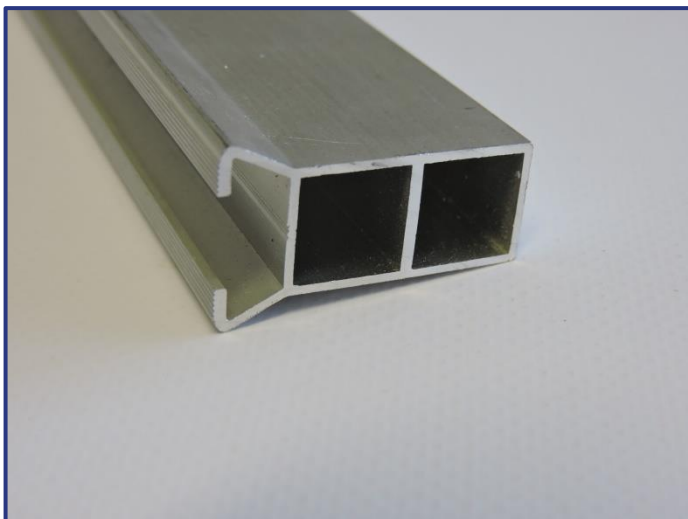

KP

Productomschrijving:

35x20mm

1 geul

0,317kg/lm

Toepassingen:

zelfdragende kaders klein formaat

spanlat aan zijkant kader

Uitvoering: alu brut of wit gelakt

Lengte: 3m50 en 7m

Accessoires: EQABS FIX 30
C15 PFIX
FIX 15 SX 30

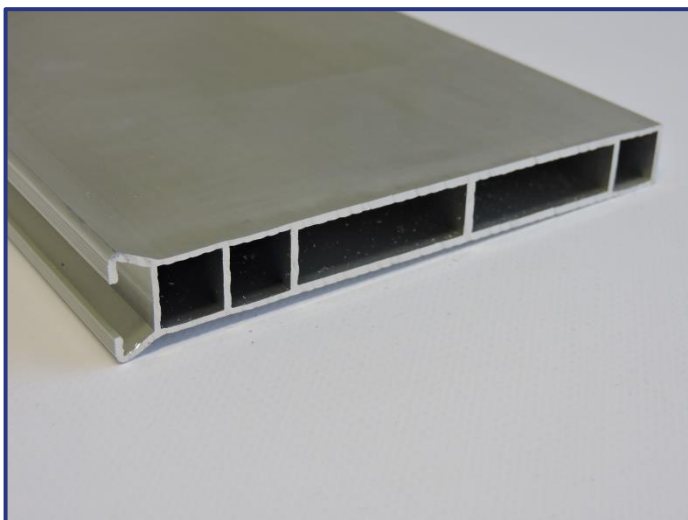

KPP

Productomschrijving:

125x20mm

1 geul

1,169kg/lm

Toepassingen:

zelfdragende kaders groot formaat

spanlat aan zijkant kader

Uitvoering: alu brut of wit gelakt

Lengte: 3m50 en 7m

Accessoires: EABQS FIX 50
SX 30 PFIX
FIX 30 SX 50

ACCESSOIRES

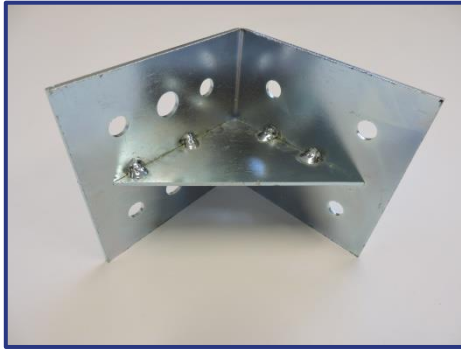

EQS100
verstekhoek 95x95mm

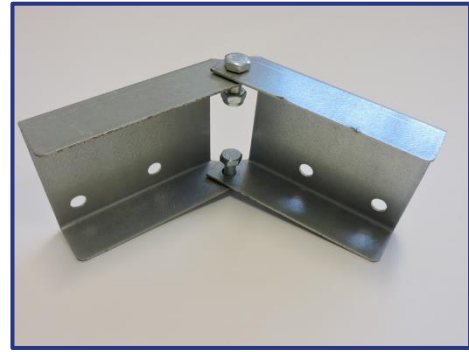

EQARTS100
scharnierstuk

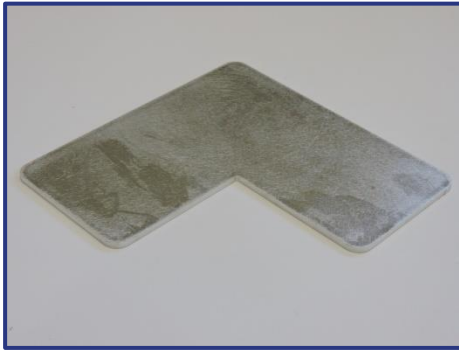

EQASS S100
vlakke verstekhoek 90°



MANCH S100
verbindingsstuk



PIED S100
voet

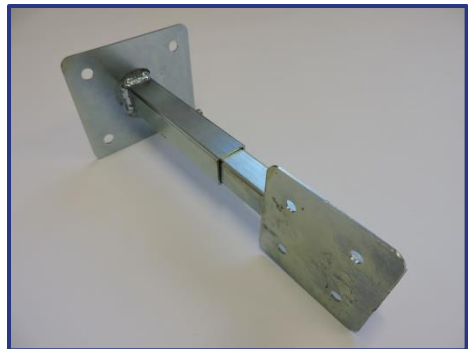

POTEN S100
afstandhouder

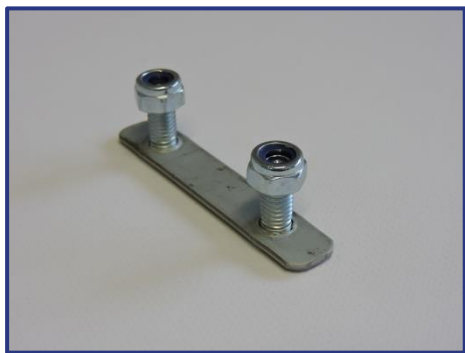

VIS S100
schroefplaatje



CLM
bevestigingsclamp

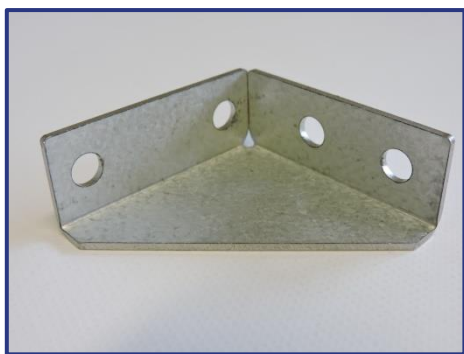

EQKT+MUR
verstekhoek voor muurbevestiging en
hoekversteviging

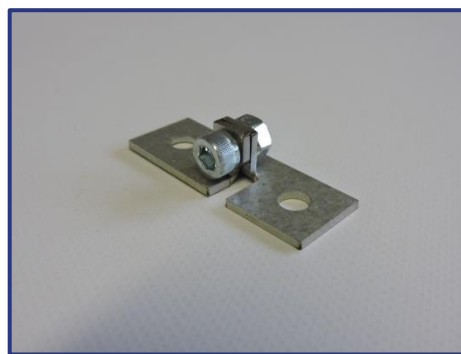

EQART KT+
scharnierstuk

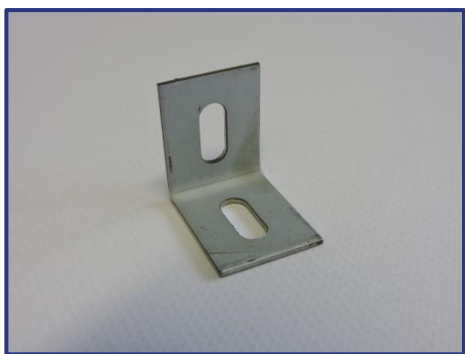

EQKT
verstekhoek 90°



EQABS
plastic verstekhoek binnenin profiel



EQABS 2
plastic verstekhoek binnenin profiel

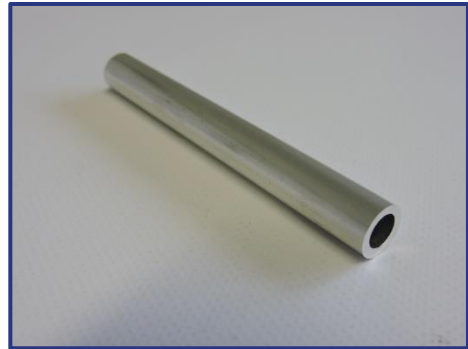

TU 10CM
verlengstaafje

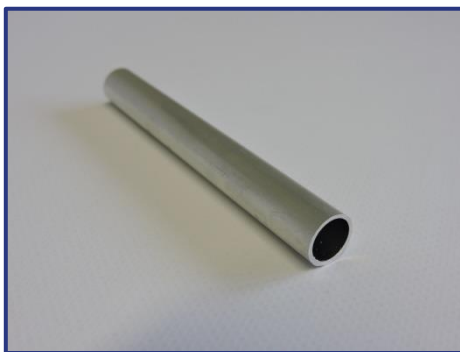

TU 12
verlengstaafje

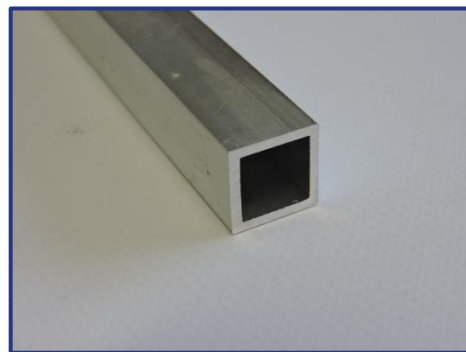

C15
versteving 15x15x1,5mm

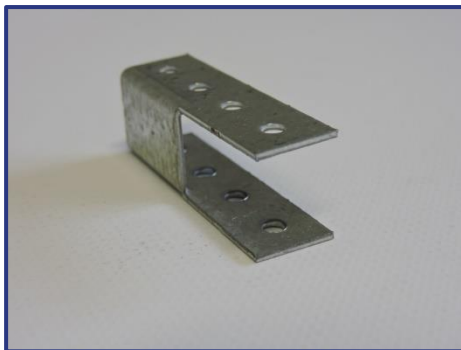

FIX 15
bevestiging versteving C15 op profiel

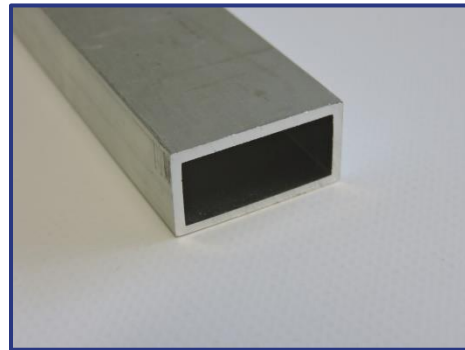

SX 30
versteving 30x15x1,5mm



FIX 30
bevestiging versterking SX 30 op profiel

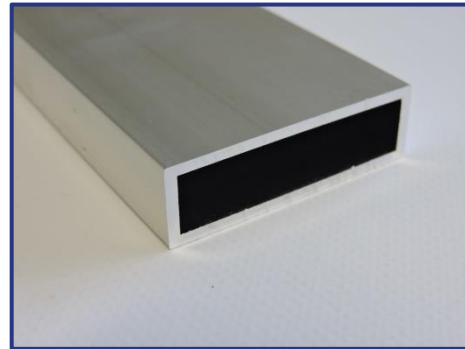

SX 50
versterking 50x15x2mm

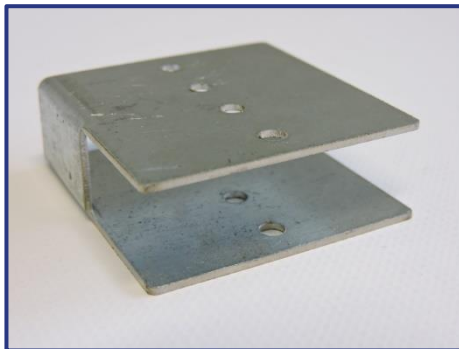

FIX 50
bevestiging versterking SX 50 op profiel

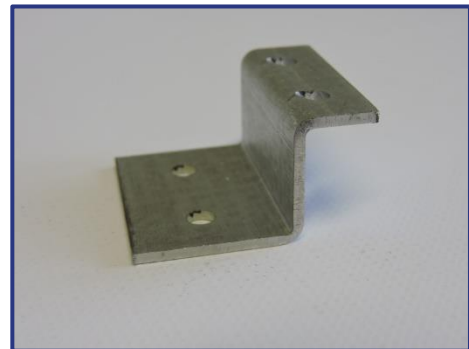

PFIX
ophangplaatje



EQ607060
verstekhoek 60x70x60mm

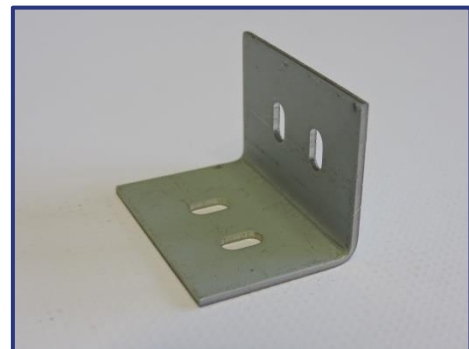

EQ
verstekhoek

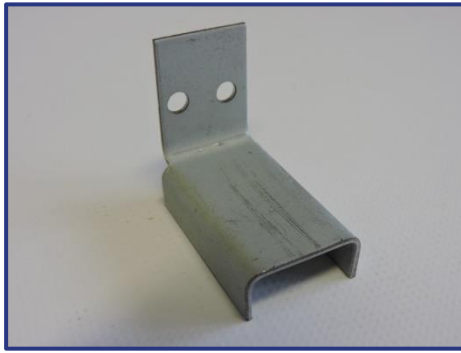

EQRAID
verbinding profiel en versteviging SX 30



EQERA
verstekhoek tussen profiel en versteviging



EQERA 2
verstekhoek tussen profiel en versteviging

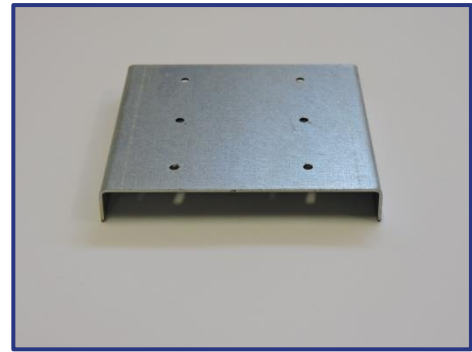

CAV
verbinding SX 50

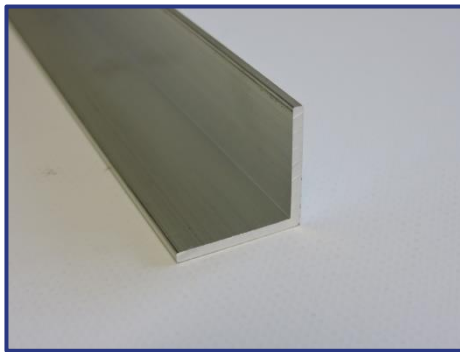

L20
L-profiel alu brut of wit gelakt 25x25mm
lengte 6m

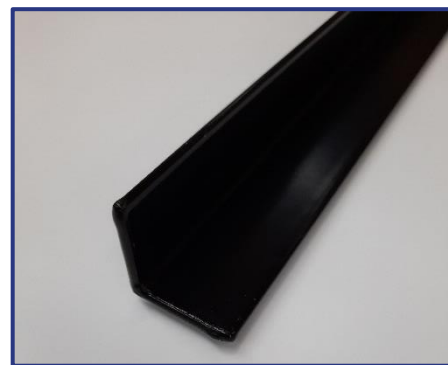

L30
L-profiel zwart gelakt 25x30mm
lengte 6m

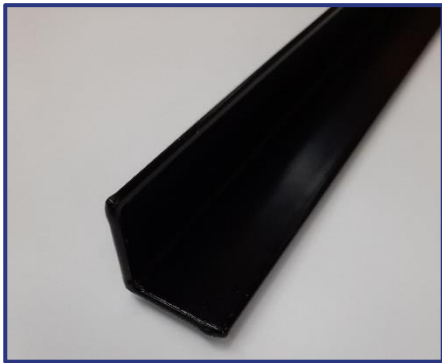

L40
L-profiel zwart gelakt 25x40mm
lengte 6m



PINCE JONC
kniptang spanlatten



MAILLET
terugslagvrije hamer

VOORBEELDEN REALISATIES



klopprofielen KT+





klopprofielen KPPS



kader met klopprofielen KT

lichtbak met KPPS



klopprofiel KT

